

NVR2882快速安装指导

NVR2882 Installation Guide

KEDACOM

一前言

感谢您购买我司产品，如对本公司产品有疑问或需要，请随时和我们联系。我们尽最大努力来保证本手册信息的正确性，如因升级等原因发生信息修改，恕不另行通知。

获取最新文档请联系产品供应商。

二安全说明

此内容（手册）的目的是确保用户正确使用本产品，以避免危险或财产损失。在使用产品之前，请认真阅读此手册并妥善保存以备日后参考。如果用户因没有按照以下安全说明，致使设备不能正常使用或损坏等情况，责任由用户承担。

- 请使用满足安全电压要求的电源。
- 如果设备工作不正常，请联系厂家或最近的服务中心。不要以任何方式随意拆卸或修改设备。
- 请不要将较重的物品摆放在NVR上，并防止设备从高处摔落或受强烈敲击。
- 避免将产品暴露在非用户手册所示的工作环境下使用。

工作环境	
工作电源	AC 100 ~240V 50 ~60Hz
温度	-10℃ ~55℃
湿度	10%~90%(无凝结)
大气压	70kPa~106kPa

- 使用时不可让任何液体流入NVR。
- 当运送NVR时，请重新以出厂时的包装进行包装，或用同等品质的材质包装。
- 需要替换部件时，请事先与经销商联系，更换指定型号的部件，或与原部件具有相同特性的部件。擅自使用其它部件进行替换，后果自负。
- 锂电池安全警告
设备内部使用的是锂电池，使用其他型号的电池可能会有爆炸危险。
更换电池时，请勿将旧电池掷入火中或与生活垃圾一起处理。
- 安装设备前，请先检查机房及四周的洁净度、防静电、防干扰、防雷击是否符合要求。若不符合，请不要急于安装设备，以免对设备造成损害。

洁净度

NVR2882对机房内的灰尘含量及粒径要求如下表所示：

最大直径 (um)	0.5	1	3	5
最大浓度 (颗粒数/m ³)	1.4×10^7	7×10^5	2.4×10^5	1.3×10^5

防静电

当静电超过一定限度时，会对设备产生一定的破坏作用。在与设备连接的通信网中，静电感应主要来自两方面：一是室外高压输电线、雷电等外界电场，二是室内环境、地板材料、整机结构等内部系统。因此，为防止静电的破坏，应保持：

设备及地板良好接地；

室内防尘；

温度、湿度条件适宜。

防干扰

设备使用中可能的干扰源（无论是来自设备，或应用系统的外部与内部）都是以电容耦合、电感耦合、电磁波辐射、公共阻抗（包括接地系统耦合）的传导方式对设备产生影响。因此，为有效抗干扰，应做到：

供电系统采取有效的防电网干扰措施；

设备工作地最好不要与电力设备的接地装置或防雷接地装置合用，并尽可能保持远距离；

远离强功率无线电发射台、雷达发射台等高频大电流设备；

必要时采取电磁屏蔽的方法。

防雷击

在雷击强度超过一定范围时可能对设备造成损害，为了有效防雷，应做到：

保证机箱外壳用接地线接地良好；

保证交流电源插座的中性点接地良好；

为增强电源的防雷击效果，可在电源的输入前端加入电源避雷器。

【说明】更多信息见附带光盘中的《NVR管理员指南》。

三产品外观

前面板

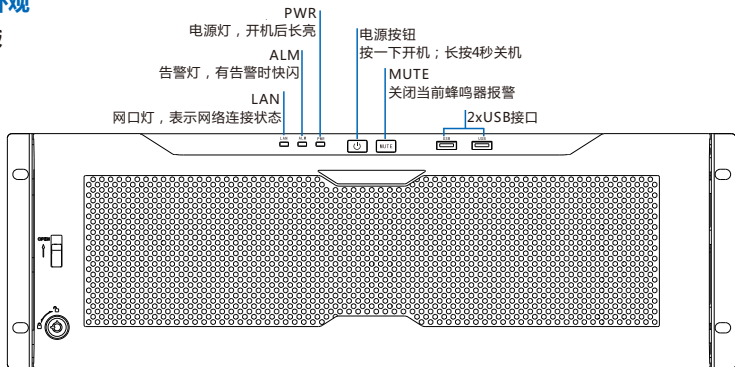

尺寸：156 mm x 483 mm x 500 mm
重量（不含硬盘）：<20 kg

后面板

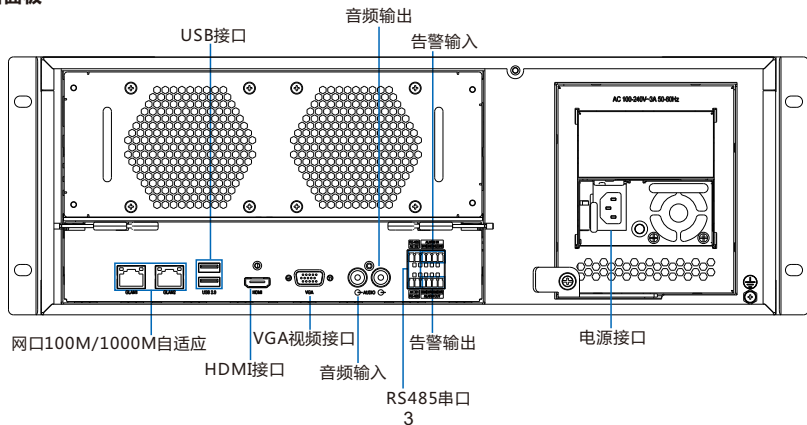

四安装设备

1. 安装前检查

- 检查包装箱物品

在安装设备之前，请先检查包装箱中的设备及组件，确保实际物品与装箱清单相符且物品无损坏现象。若发现问题，请及时与供应商或客服联系。

- 开工必备

安装NVR，以下为必备组件：

NVR2882网络录像机

1.5m网线

钥匙

主板盒体

500W电源

1x6P端子

硬盘盒部件

鼠标

产品光盘

2. 安装主板和电源

1) 从包装箱中取出主板盒和电源。

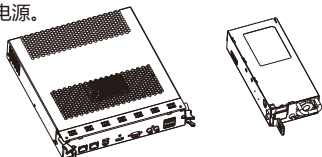

2) 将主板盒和电源分别对准设备后面板相应位置，往里推入卡紧。

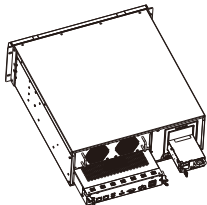

- 3) 由于更换部件等原因需要时，可在设备断电后抽出主板盒和电源。抽出电源时，往右推动电源前面卡扣的同时往外拉，即可抽出电源。抽出主板盒时，两手分别按住电源盒前面的卡扣并往外拉即可抽出主板盒。

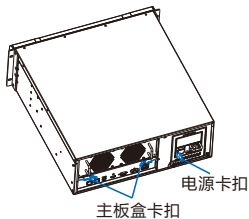

3. 将NVR安装到机架上

安装前，请确保安装环境通风良好，并安装硬盘，硬盘安装方法见附录部分。

将NVR安装到机架上，必须要有托盘。

安装方法:

- 1) 将两个挂耳分别用螺钉固定在设备的两侧,如下图所示。

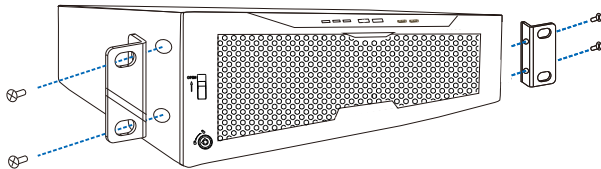

- 2) 将设备水平放在托盘上，使两侧挂耳的螺孔与机架上的螺孔重合，然后用螺钉固定。

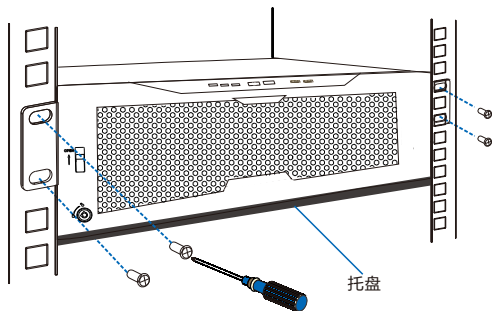

4. 线缆连接

设备摆放好后，开始线缆连接。按照如下图所示，进行线缆连接。

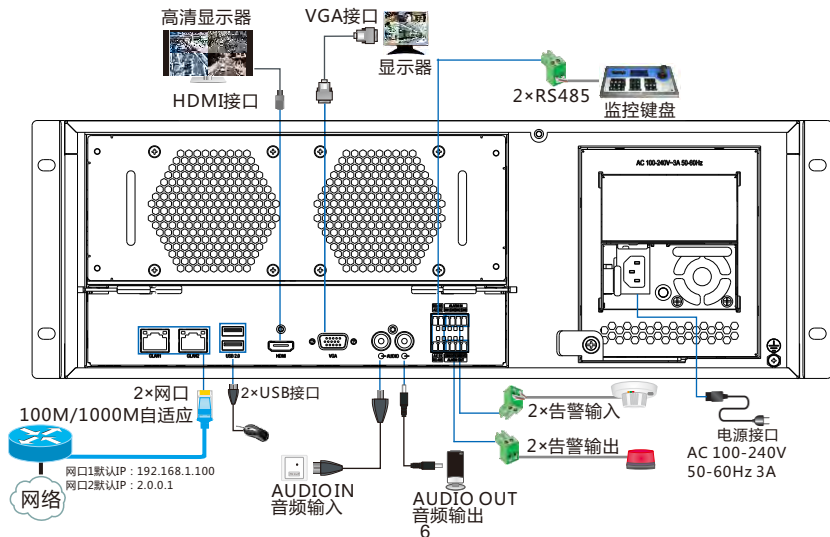

5.上电、开机

连接完成后，给设备上电，开机。

开机后自动进入画面浏览并录像。点击任意选项，系统将弹出用户登录对话框，如图。

默认用户名：admin。

初始密码：admin123。



点击弹出软键盘

登陆设备后，可通过图形界面(GUI)对NVR进行配置。具体配置方法可参考随机光盘手册《NVR管理员指南》。

用户也可选择在PC机上通过NVRStation进行初始配置，配置方法可参考随机光盘手册《NVRStation操作手册》和客户端帮助文档。

附 硬盘安装方法

1

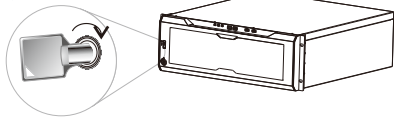

将钥匙往里推，顺时针转动开锁

2

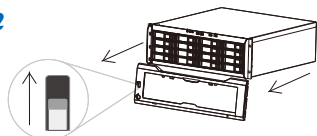

推动滑块，卸下保护盖，露出硬盘支架

3

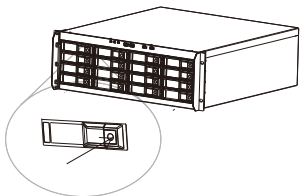

按下按钮，硬盘盒盖自动弹开

4

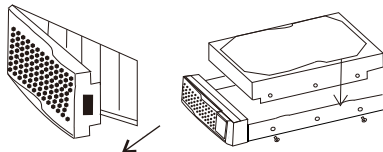

盒盖开启后，向外拉出硬盘盒 用四颗螺钉固定硬盘

5

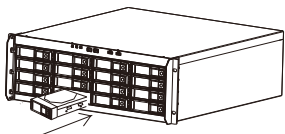

推入硬盘盒，关上盒盖

6

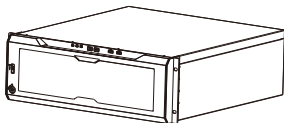

盖上保护盖，上锁

- 【说明】** 1) 硬盘安装需将四颗螺丝都拧上，且四颗螺丝都拧紧；
2) 建议使用兼容硬盘列表中推荐的硬盘型号，兼容硬盘列表见随机光盘手册。

保修说明

本保修卡适用于您购买的本公司系列产品。

1.终身保质，免费保修期一年（仅限中国大陆地区，中国大陆以外地区请参考英文说明）。

2.凡保修期内，由于本产品自身引起的故障，请与公司售后服务部联系。

3.保修时我们将使用您的保修卡信息，请认真填写。

4.以下情况，属于有偿保修范围：

- 人为原因造成的设备故障
- 因使用环境不符合本产品要求造成的故障
- 因不可抗力造成的产品损坏
- 无保修卡
- 已过保修期

用户信息

用户名称：

详细地址：

传真：

电话：

邮箱：

邮编：

产品名称：

产品型号：

购买日期：

Trademarks

Kedacom™, TrueSens™ and **KEDACOM**™ are registered trademarks of Suzhou Keda Technology Co., Ltd. in China and various other countries. All other trademarks mentioned in this document are the property of their respective holders.

Suzhou Keda Technology Co., Ltd.

131 Jinshan Road

New District, Suzhou, 215011

People's Republic of China

<http://www.kedacom.com/en>

Tel: +86-512-68418188

Fax: +86-512-68412699

© 2015 Suzhou Keda Technology Co., Ltd. All rights reserved.

Without the prior written permission of Suzhou Keda Technology Co., Ltd., any reproduction, translation or retransmission of all or any part of this document for any purpose in either electronic or mechanical form is not allowed.

Notice

The information in this document is subject to change without notice. Every effort has been made in the preparation of this document to ensure accuracy of the contents, but all statements, information, and recommendations in this document do not constitute a warranty of any kind, express or implied. Suzhou Keda Technology Co., Ltd. is not responsible for printing or clerical errors.

About the NVR2882

1 Product Introduction

The NVR2882 is a turnkey solution for video surveillance and video recording. The NVR2882 supports Open Network Video Interface Forum (ONVIF) and Real Time Streaming Protocol (RTSP) interoperability standards. Additionally, the NVR2882 features native integration to cameras and encoders from third party manufacturers, therefore making it an open system. The advanced system capabilities make the NVR2882 easy to use with functions like Automatically Adding Devices and One-Click Partition and Initialization and meet various customer needs with functions like Record Fragment and Privacy Mask for every day security users to advanced video surveillance users.

[Note] The NVR2882 is referred to as the NVR in the following description.

The NVR works with the following management system and applications:

- NVR Station: is a complete system for device management, video surveillance, and video recording.
- NVR Station Web: is a web-based application of the NVR Station.
- Mobile NVR Client (MNC): is an iOS/Android-compatible mobile application of the NVR Station.

2 Product Appearance

2.1 Front Panel

On the front panel of the NVR, you can see the following items:

- One LAN indicator
- One ALM indicator
- One PWR indicator
- One power button
- One mute button (for the beeper)
- Two 2.0 USB ports

The following table helps you read the preceding indicators.

Indicator	State	Description
LAN	Green	The system is connected to the Internet.
	Off	The system is disconnected from the Internet.
ALM	Off	No system alarm is triggered.
	Blinking red(0.25s on and 0.25s off)	A system alarm is triggered.
PWR	Green	When the system is just started, the indicator will blink once. When the system starts operating, the indicator is steady green.
	Off	The system is powered off or is rebooting.

The following figure shows the front panel of the NVR.

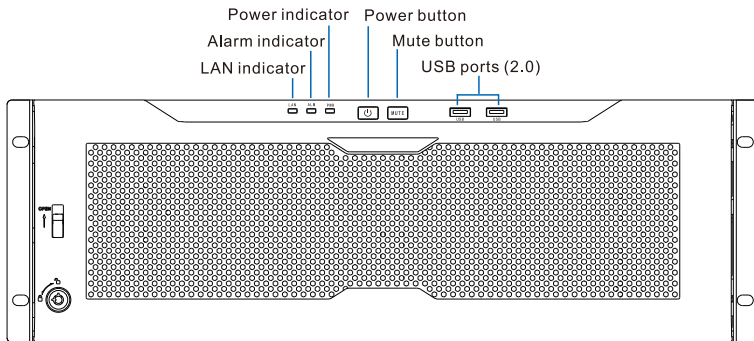

2.2 Rear Panel

The following figure shows the rear panel of the NVR.

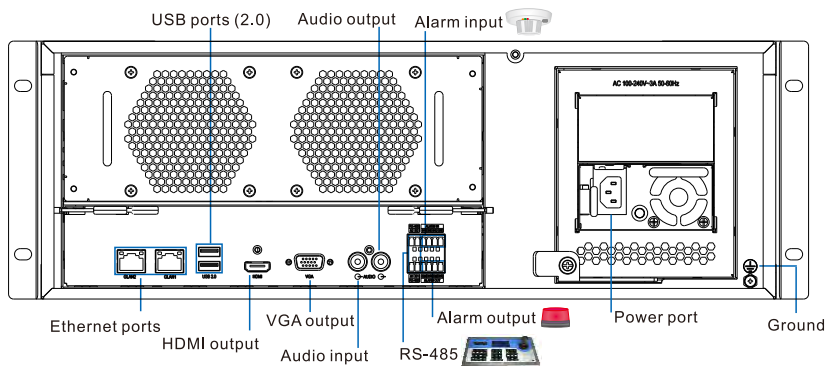

Installing the NVR2882

1 Preparations

1.1 System Specifications

Ensure that the specifications of the NVR are complied with. For example, the operating temperature for the NVR must be within the range of -10°C to 55°C .

For the physical specifications of the NVR, see chapter 3 "Physical Specifications."

1.2 Equipment Cleanliness

The following table provides the mapping between the particle diameter range and number of particles per cubic meter.

Particle Diameter Range	Number of Particles per Cubic Meter
[0, 0.5]	1.4×10^7
[0.6, 1]	7×10^5
[1.1, 3.0]	2.4×10^5
[3.1, 5.0]	1.3×10^5

You must install the NVR in an environment as free from dust and foreign conductive material (such as metal flakes from construction activities) as is possible.

1.3 ESD

To reduce the effects of electrostatic discharge (ESD), you should observe the following guidelines.

- Wear a grounding wrist strap. If a grounding wrist strap is unavailable, touch an unpainted metal surface on the appliance chassis periodically to neutralize any static charge.
- Keep components in their antistatic packaging until they are installed.
- Avoid wearing clothing made of wool or synthetic materials.
- Ensure that the NVR is well grounded.
- Keep the area around the NVR clean, free of clutter, and well ventilated.
- Ensure that the operating temperature and the relative humidity within the range complying with the NVR.

1.4 EMI

To shield electromagnetic interference (EMI), you should observe the following guidelines:

- Keep the ground system of the NVR away from that of the power supply system or lightning protection system.
- Place the NVR away from high-frequency devices, such as radio or radar stations.
- When necessary, deploy EMI shielding devices.

2 Unpacking

Perform the following steps to unpack the system:

- 1) Inspect the package to make sure that it has not been damaged.
If you find damage, contact the local authorized Kedacom agent.
- 2) Open the package and check whether any item on the packing list is missing.
- 3) Take all items out of the package and check whether any item is in poor condition.
If you find damage, contact the local authorized Kedacom agent.

3 Installing Disks

The NVR can be mounted on a 19-inch rack and it is around 3.5U high. Before mounting the NVR on a 19-inch rack, you must install disks.

If you do not install a disk:

- You cannot use the recording function.

- When the NVR starts operating and detects that no disk is installed, the beeper will go off and an alarm will be generated. To clear the alarm, on the OSD of the NVR, choose **Main Menu > Alarm > Active Alarm**, and then select the alarm and click **Clear**.

To install a disk:

1. Insert the included key into the lock on the front panel of the NVR and turn the key clockwise to unlock the slider.

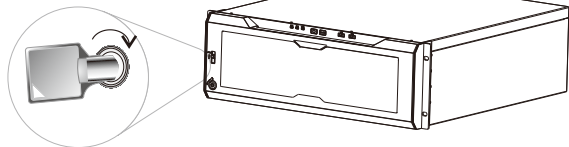

2. Push the slider up to remove the protection mask from the NVR.

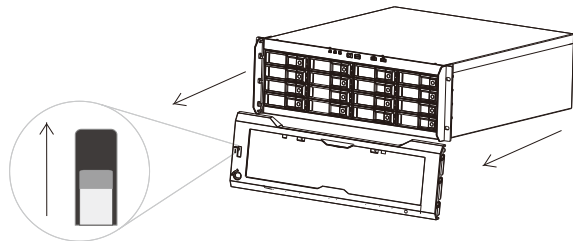

3. Press the button on the front panel of a hard disk tray until the cover on the front panel pops open.

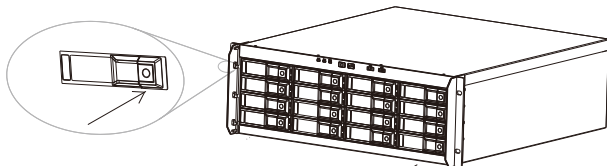

Repeat this step for all the disks that you want to install.

4. Take out the hard disk tray, put a disk inside the tray, and fasten the disk to the tray using the included screws.

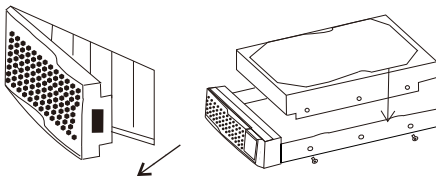

Repeat this step for all the disks that you want to install.

5. Slide the tray into a disk slot along the rails of the disk slot. Note that you must keep the cover on the front panel of the tray open.

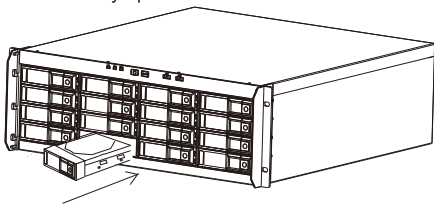

Repeat this step for all the disks that you want to install.

6. Press the cover on the front panel of the tray until you hear a click indicating that the tray is locked into the disk slot.
7. Push and hold the slider up to install the protection mask back to the NVR.
8. Release the slider.
9. Slide the included key into the keyway of the lock on the front panel of the NVR and turn the key counterclockwise to lock the slider.

4 Installing the NVR

In a well ventilated area, install the NVR in a 19-inch rack as follows:

1. Insert the mother board and power module into respective slots on the rear panel until you hear a click indicating that the board and module fit into the NVR cabinet completely.
By default, the NVR comes with only one power module.

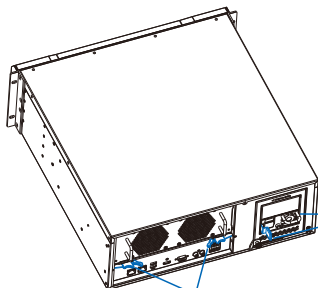
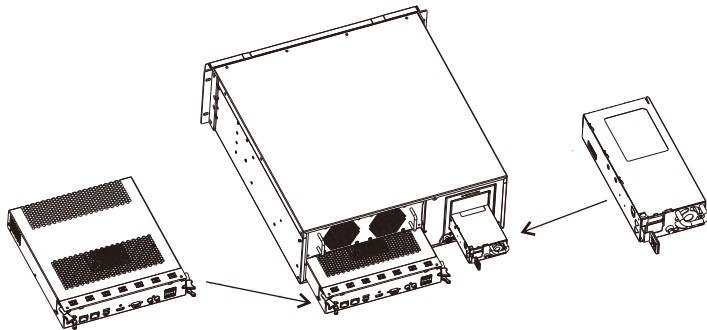

To pull out the power module:
1) Push the plastic lock rightwards.
2) Hold the lock and pull the handle.

To pull out the mother board:
1) Squeeze two plastic locks together on both sides.
2) Hold the locks and pull out the mother board.

2. Choose a suitable location for the rack that is near a grounded power outlet.
Ensure that the rack is at least 0.6 m far away from the wall.
Leave at least 1.5 m of space in the front of the NVR.
3. Install the chassis provided by the rack manufacturer.
4. Place the NVR on the chassis.
5. Fasten the hangers on the left and right sides of the NVR to the rack with screws provided by the rack manufacturer through the four holes in the hangers.

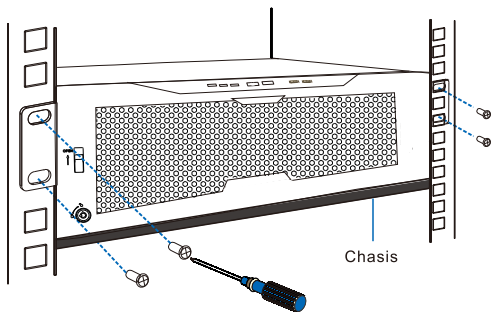

6. Connect the green-yellow wire to the ground bolt of the NVR.
7. Connect the G-LAN1 network port to the Internet.
Depending on onsite conditions, connect the GLAN2 network port to the Internet.
You are advised to use RJ-45 network cables.
8. Connect the NVR to a display that provides an HDMI and/or VGA port.
9. Connect the power cable to a power outlet.

[Note] You can connect the NVR to other devices (for example, a speaker). However, this document does not provide the corresponding details. If you are experiencing trouble connecting the NVR to other devices, contact the local authorized Kedacom agent.

After the installation is completed, please note the following:

- By default, the NVR is switched on as soon as it is connected to a power outlet.
- To switch off the NVR, click the related button on the OSD of the NVR or on the NVR Station. Alternatively, press and hold the power button on its front panel for 4s.
- The NVR Station is included in the KEDACOM Document and Utility CD. You can also go to <http://www.kedacom.com/en/downloads.html> to download the NVR Station. For details on how to use the NVR Station, see *NVR Station User Guide*.
- To switch on the NVR, press the power button on its front panel.

5 Power-on Self-Test

1. After the system is switched on, check whether the LAN indicator on the front panel is lit.
 - If yes, skip to step 3.
 - If not, proceed to step 2.
2. Check whether the mother board fits into the NVR cabinet completely.
 - If yes, contact the local authorized Kedacom agent.
 - If not, switch and power off the NVR and insert the board into the specific slot on the rear panel until you hear a click. Then, go back to step 1.
3. After the system is started up, check whether the status of the LAN and PWR indicators on the front panel is normal.
 - If yes, the system is operating properly.
 - If not, contact the system administrator or the local authorized Kedacom agent.

6 Product Care

6.1 Lightning Protection

To prevent the risk of lightning, you are advised to ensure the following:

- The NVR is well grounded.
- The green-yellow wire is properly connected to the ground bolt of the NVR.
- The connection between the natural points of alternating current (AC) outlets and the earth ground is normal.
- Based on onsite conditions, install lightning arrestors.

6.2 Lithium Battery Replacement

The system clock uses the CR2032 button cell lithium battery. When the battery loses its charge, the system may malfunction. You must call the local unauthorized Kedacom agent to replace the battery. Do not attempt to replace the battery yourself.

Dispose of used batteries according to the manufacturer's instructions. If instructions are unavailable, contact your local waste disposal agency to learn about the nearest battery recycling place.

6.3 Miscellaneous

Do not place heavy objects on the NVR.

Do not block the air vent.

Switch off the NVR if you are not using the NVR for a long period of time.

Regularly check the status of hubs and switches to ensure that the NVR is properly connected to the Internet.

Physical Specifications

The following table provides the physical specifications of the NVR.

Power	100 V AC to 240 V AC
Operating frequency	50 Hz to 60 Hz
Rated power	<50 W (excluding disks)
Operating temperature	-10 °C to 55°C
Relative humidity	10% to 90% (non-condensing)
Atmosphere pressure	70 kPa to 106 kPa
Altitude	-60 m to 3000 m
Size(height x width x depth)	156 mm x 483 mm x 500 mm
Weight	<20 kg (excluding disks)

This page is intentionally left blank.

This page is intentionally left blank.

Kedacom Two (2) Year Limited Hardware Warranty

WHAT IS COVERED BY THIS WARRANTY?

Kedacom warrants the Kedacom-branded hardware product and accessories contained in the original packaging (hereinafter referred to as "Kedacom Product") against defects in materials and workmanship when used normally in accordance with Kedacom's published guidelines for a period of TWO (2) YEARS from the date of original retail purchase in areas other than mainland China by the end-user purchaser (hereinafter referred to as "Warranty Period"). For the Kedacom Product purchased in mainland China, see the simplified Chinese version of this warranty for details. Kedacom's published guidelines include but are not limited to information contained in technical specifications, user guides, and service communications. The preceding applies unless otherwise agreed in the contract.

WHAT IS NOT COVERED BY THIS WARRANTY?

This warranty does not apply to any non-Kedacom branded hardware products or any software, even if packaged or sold with Kedacom hardware. Manufacturers, suppliers, or publishers, other than Kedacom, may provide their own warranties to you but Kedacom, in so far as permitted by law, provides their products "AS IS". Software distributed by Kedacom with or without the Kedacom brand (including, but not limited to system software) is not covered by this warranty. Please refer to the licensing agreement accompanying the software for details of your rights with respect to its use. Kedacom does not warrant that the operation of the Kedacom Product will be uninterrupted or error-free. Kedacom is not responsible for damage arising from failures to follow instructions relating to the Kedacom Product's use.

This warranty does not apply: (a) to consumable parts, such as batteries, unless failure has occurred due to a defect in materials or workmanship; (b) to cosmetic damage, including but not limited to scratches, dents, and broken plastic on ports; (c) to damage caused by use with another product; (d) to damage caused by acts outside the control of Kedacom, including without limitation acts of God, accidents, abuse, misuse, fire, storms, earthquakes, flood, or other external cause; (e) to damage caused by exposure of the product to heat, bright light, sun, liquids, sand, or other contaminants; (f) to damage caused by operating the Kedacom Product outside Kedacom's published guidelines; (g) to damage caused by service (including upgrades and expansions) performed by anyone other than a representative of Kedacom, Kedacom employee, or authorized Kedacom agent; (h) to an Kedacom Product that has been modified to alter functionality or capability without the written permission of Kedacom; (i) to defects caused by normal wear and tear or otherwise due to the normal aging of the Kedacom Product, or (j) if any serial number has been removed or defaced from the Kedacom Product.

YOUR RESPONSIBILITIES

If your Kedacom product is capable of storing data and other information, you should make periodic backup copies of the information contained on the storage media to protect the contents and as a precaution against possible operational failures.

Before receiving warranty service, Kedacom or its authorized agents may require that you furnish proof of purchase details, respond to questions designed to assist with diagnosing potential issues, and follow Kedacom's procedures for obtaining warranty service. Before submitting your Kedacom Product for warranty service, you should maintain a separate backup copy of the contents of its storage media, remove all personal information that you want to protect, and disable all security passwords.

During warranty service, it is possible that the contents of the Kedacom product's storage media will be lost, replaced or reformatted. In such an event, Kedacom and its authorized agents are not responsible for any loss of data or other information contained on the storage media or any other part of the Kedacom product serviced.

Following warranty service, your Kedacom Product or a replacement product will be returned to you as your Kedacom Product was configured when originally purchased, subject to applicable updates. You will be responsible for reinstalling all other data and information. Recovery and reinstallation of other data and information are not covered under this warranty.

WHAT WILL KEDACOM DO IF THE WARRANTY IS BREACHED?

If during the Warranty Period, you submit a valid claim to Kedacom or an authorized Kedacom agent, Kedacom will, at its option, (i) repair the Kedacom Product using new or previously used parts that are equivalent to new in performance and reliability, or (ii) exchange the Kedacom Product for a refund of your purchase price.

A Kedacom replacement part or product, including a user-installable Kedacom part that has been installed in accordance with instructions provided by Kedacom, assumes the remaining warranty of the Kedacom Product or ninety (90) days from the date of replacement or repair, whichever provides longer coverage for you. When a product or part is replaced or a refund provided, any replacement item becomes your property and the replaced or refunded item becomes Kedacom's property.

Kedacom reserves the right to refund the purchase price as its exclusive warranty remedy.

HOW TO OBTAIN WARRANTY SERVICE?

To seek warranty service, please contact a local authorized Kedacom agent. When contacting the agent via telephone, other charges may apply depending on your location.

User Information

Complete the form below and keep for ready reference.

User Name:	
Address:	Postal Code:
Tel:	Mobile:
Fax:	E-Mail:
Product Name:	Product Model:
Date of Purchase:	

客户咨询热线：**800-828-2866** **400-828-2866**

KEDACOM

苏州科达科技股份有限公司

Suzhou Keda Technology Co.,Ltd.

中国: 江苏省苏州市高新区金山路131号(215011)

Tel: +86-512-68418188 Fax: 86-512-68412699

Suzhou Keda Technology Co.,Ltd.

Singapore: 627A Aljunied Road, #09-07, BizTech Centre, Singapore 389842

Tel: +65-6842-5700 Fax: +65-6842-5900